

Technical Datasheet



GR Series

Pressure Difference Switch

Models: GR3 & GR6

Key Features

- Compact and rugged design.
- Weatherproof IP66/NEMA 4
- ATEX Flameproof CENELEC Ex d IIC option
- Stainless steel body option NEMA 4X rating
- Optional weatherproof, ATEX Ex e, ATEX Ex ia or ATEX - Flameproof Ex d IIC terminal enclosures
- NACE MR-01-75 compatibility.
- Ranges available up to 10 bar (160 psi). Static Pressure up to 250 bar (3,500 psi).
- Field adjustable.
- Hermetically sealed snap switch CSA listed.



Product applications

The GR Series is suitable for a wide range of applications in:

- Oil & Gas
- Chemical
- Petrochemical
- OEM

The choice of models available ensures that the GR Series is suitable for use in:

- Corrosive atmospheres
- Resistant to chemical attack

Series Overview

- Launched in the mid-1990s, the Compact Series pressure switches provide users with a compact, robust and hermetically sealed switch for use in Safe and Hazardous Areas.
- The GR Series switches are all housed in a compact and rugged enclosure making them particularly suitable for panel mounting in harsh environments
- All models in the Compact Series come with hermetically sealed switch contacts and flying leads as standard.

Other products in the series include:

- Pressure Switches: Model GR2/4
- Temperature Switches: Model GR7



How can we help you?

Delta Mobrey offers fast, efficient and knowledgeable support when and where you need it. Please visit our web site at www.delta-mobrey.com to find your local support centre or call us on:

+44 (0) 1252 729140

GR Series
Models: GR3 & GR6

How to order

Switches can be configured by selecting codes representing the desired features from the tables that follow. The chart below, describes how the model code is built up. For assistance in configuring a switch that best suits your needs, please contact your local sales office.

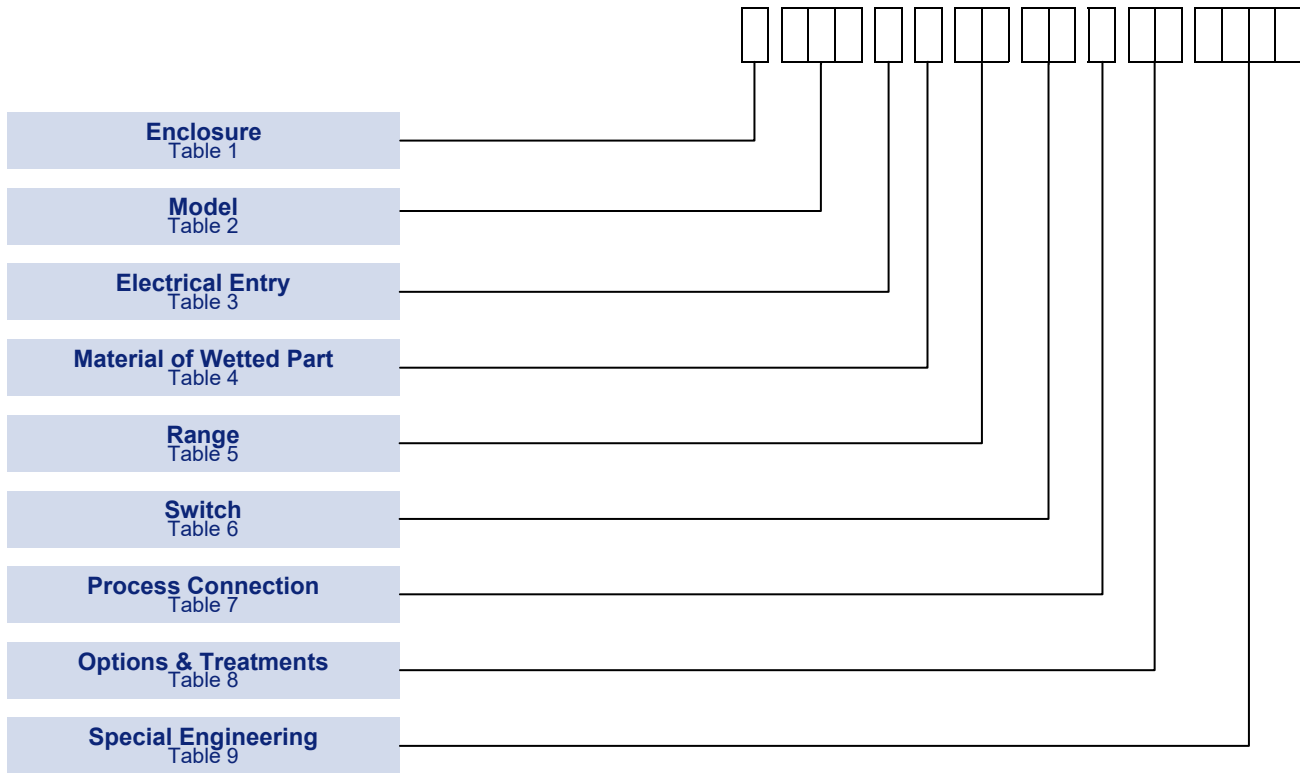

NOTE: Options shaded in the following tables are the most common options and are available on the quickest lead-times and at the lowest cost.

NOTE: Only the most common options are shown in this data sheet. Should you require a feature that is not shown, please contact your local sales office for further details.

Technical Specification

GR Series Models: GR3 & GR6	Accuracy:	Set point repeatability ± 1% of span at 20°C / 68°F ambient
	Storage Temperature:	-40 to +60°C / -40 to +140°F
	Ambient Temperature:	Certified Enclosures. Refer to Approvals and Tables 1 & 3 for limitations of ambient use.
	Maximum Process Temperature:	Subject to appropriate installation practice, the component parts will withstand up to +60°C (+140°F). For process temperatures up to +120°C (+248°F), order WETTED PARTS Code R (Table 4). For higher temperatures, refer to SPECIAL ENGINEERING.
	Enclosure classification:	IP66 / NEMA 4X / Flameproof Ex d
	Switch output:	SPDT or DPDT snap action hermetically sealed microswitch
	Electrical rating:	See Table 6
	Process Connection:	Rc ¼ (BSP), 1/4 NPT Internal, 1/2 NPT Internal & 1/2 NPT External
	Approximate Weight:	Enclosures “H, T & W” 2.7kg/6lb to 6.8kg/15lb; “R, A & U” 3.5kg/7.7lb to 7.3kg/16lb. For integral terminal enclosures codes in Table 3 “C & D” 0.3kg/0.66lb; “J” 1.1kg/2.4lb; “K” 0.4kg/0.88lb.

Enclosure





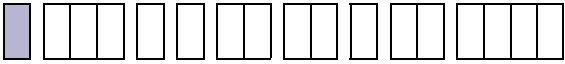

FINISH

Enclosures W, H and T are clear anodized aluminium; Epoxy paint is optional see Code 50 in Table 8. A and R are natural finish stainless steel.

All are suitable for use in hazardous areas as defined by NEC Article 500, Class 1 Groups A, B, C, D Class II Groups E, F, G Division 1 and 2.

See Table 3 Code A.

TABLE 1 

ENCLOSURE TYPES	Code
WEATHERPROOF ENCLOSURES	
General purpose The basic enclosure offers weather protection Not less than NEMA 4 / IP66.	W
For Aggressive Atmospheres Stainless Steel with weather protection not less than NEMA 4X / IP66.	A
FLAMEPROOF ENCLOSURES (ZONE 1)	
ATEX Ex d IIC T6 (-40 to +65°C) T4 (-40 to +85°C) II 2 G Aluminium enclosure, suitable for outdoor use, IP66, NEMA 4, 7, 9. <div style="text-align: right;"> II 2G</div>	H
ATEX Ex d IIC T6 (-40 to +65°C) T4 (-40 to +85°C) II 2 G For Aggressive Atmospheres Stainless Steel enclosure, suitable for outdoor use, IP66, NEMA 4, 7, 9. <div style="text-align: right;"> II 2G</div>	R
NEC 500, NEMA 4, 7, 9 Anodized aluminium. Weatherproof to NEMA 4 / IP66 <div style="text-align: right;"></div>	T
NEC 500, NEMA 4X, 7, 9 Austenitic Stainless Steel. Weatherproof to NEMA 4X / IP66. <div style="text-align: right;"></div>	U
INTRINSICALLY SAFE ENCLOSURES (ZONE 0)	
ATEX Ex ia IIC T6 Ga Ex ia IIIC T85°C Da IP6x (-40 to +60°C) or T4 Ga Ex ia IIIC T135°C Da IP6x (-40 to 85°C) II 1GD As code 'W' but Ex ia. Weatherproof to NEMA 4 / IP66. <div style="text-align: right;"> II 1GD</div>	5
ATEX Ex ia IIC T6 Ga Ex ia IIIC T85°C Da IP6x (-40 to +60°C) or T4 Ga Ex ia IIIC T135°C Da IP6x (-40 to 85°C) II 1GD As code 'A' but Ex ia. Weatherproof to NEMA 4X / IP66. <div style="text-align: right;"> II 1GD</div>	4

Models

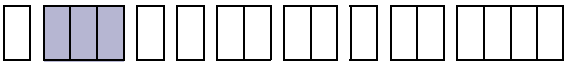
TABLE 2 

	Code
Fixed Switching Differential For applications up to 10 bar / 160 psi Over-range up to 110bar/1600psi See Table 5	GR3
Fixed Switching Differential For applications up to 10 bar / 160 psi Over-range up to 250bar/3500psi See Table 5	GR6

GR Series
Models: GR3 & GR6

Electrical Entry

See **TECHNICAL DATA** and **DIMENSIONS** fig 1 to 5.

NOTE 1:

Other lengths available - please contact sales for engineering codes





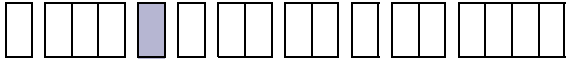

NOTE 2:

Weatherproof terminal enclosure Code C can only be combined with Table 1 Enclosure Codes W and A

NOTE 3:

Intrinsically Safe terminal enclosure Code V and W can only be combined with Table 1 Enclosure Codes 4 and 5

TABLE 3 

	Code
Factory Sealed Flying Lead. See fig 1, 2, 3 & 4. Class 1, Groups A, B, C, D. Class II Groups E, F, G (NOTE 1) 0.45m/18in. Long flying lead. With 1/2-14 NPT external conduit thread. 	A
Integral Weatherproof Terminal Enclosure. See fig 5. Glass filled polyester with weather protection to IP66/NEMA 4. Conduit entry tapped M20 x 1.5 (NOTE 2) Ambient temperature -20°C to +40°C.	C
Integral 'Increased Safety' Terminal Enclosure. See fig 5. Ex e IIC T6 (-20 to +40°C) Glass filled polyester with weather protection not less than IP66/NEMA 4. Conduit entry tapped M20 x 1.5.  II 2G	D
Integral 'Increased Safety' Terminal Enclosure. See fig 5. Ex e IIC T6 (-20 to +40°C) Glass filled Hawke Type PL612 polyester with weather protection not less than IP66/NEMA 4. Conduit entry tapped M20 x 1.5.  II 2G	J
Explosionproof Terminal Enclosure. See fig 5. CENELEC Exd IIC T6 (-20 to +40°C) Die cast aluminium alloy. Weather protection not less than IP65/NEMA 4 Conduit entry tapped 1/2-14 NPT.  II 2G	K
Intrinsically Safe Terminal Enclosure-With Screw Terminals. See fig 2. Ex ia IIC T6 (-20 to +40°C) Glass filled polyester, with weather protection not less than IP66/NEMA 4.  II 1GD	V
Intrinsically Safe Terminal Enclosure-With DIN Rail Mounted Terminals. See fig 2. Ex ia IIC T6 (-20 to +40°C) Glass filled polyester IEC 61241-0:2004 and EN61241-11:2005, with weather protection not less than IP66/NEMA 4.  II 1GD	W

Material of Wetted Parts

GR Series
Models: GR3 & GR6

For aluminium flanges (Code D) select only from enclosures codes H, T and W. For Cast Iron flanges (Code E) select only from enclosure codes R, A and U. See Table 1.

TABLE 4 

RANGES	See Fig. 2 to 4 for dimensions	Code
BD-EA	316 Stainless steel diaphragm. All other wetted parts fully austenitic 300 series stainless steel. PTFE and Nitrile seals	I
	316 Stainless steel diaphragm. All other wetted parts fully austenitic 300 series stainless steel. PTFE and Viton seals.	R
	For wetted parts required to conform with Sour Gas or Sour Crude applications as laid down in NACE standard MR-01-75.	L
BC	Nitrile diaphragm and seal with aluminium flanges.	D
	Nitrile diaphragm and seal with cast iron flanges.	E

Setting Ranges

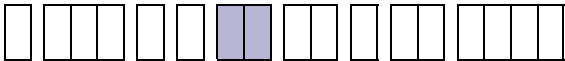
TABLE 5 

P_{max} = maximum working pressure

When ordering, please state units required. Range and set point will be in units preference. Unless otherwise stated, units will be in bar/mbar.

The instrument will sustain, without loss of performance, a continuous forward over pressure equal to the maximum static pressure and/or full vacuum.

NOTE: For pressure difference switches maximum working pressure (P_{max}) and maximum static/line pressure mean the same.

Model	P_{max}		Range			Code
	bar	psi	mbar/bar	Code	in H ₂ O/psi	
GR3	1.0	14.5	-12.5 to +12.5	BC*	-5.0 to +5.0	BU*
GR3 (GR6)	110 (250)	1600 (3500)	6 to 40	BD (0D)	2.5 to 16	BY (0Y)
GR3 (GR6)	110 (250)	1600 (3500)	25 to 160	CB (0B)	10 to 64	CS (IS)
GR3 (GR6)	110 (250)	1600 (3500)	100 to 600	CE (0E)	1.5 to 8.5	CK (0K)
GR3 GR6	110 250	1600 3500	0.4 to 2.5	DC	6 to 40	DP
GR3 GR6	110 250	1600 3500	0.6 to 4	DD	10 to 60	DT
GR3 GR6	110 250	1600 3500	1.6 to 10	EA	25 to 160	EH

*Forward overpressure is limited to 500 mbar

Maximum static/line pressure applied in the reverse direction (i.e., to low pressure connection with high pressure connection open to atmosphere) will be contained without failure. The diaphragm on ranges BD to EA (BY to EH) will however have been distorted, leading to a degradation of performance and a shortening of the service life.

For applications where regular reversals of pressure are inevitable, a special engineering facility is available, see Table 9.

Switch Options

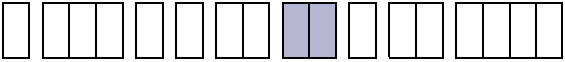
TABLE 6 

Model GR3/4								
CSA RATING	IEC947-5-1 / EN 60947-5-1 RATING						Contact	Code
	Designation & Utilization Category	Rated operational current I_e (A) At rated operational voltage U_e	U_i	U_{imp}	VA Rating			
					Make	Break		
11 Amps @ 110/250V AC and 5/0.5 Amps @ 30/125V DC Silver contacts	AC14 D300	0.6/0.3A @ 120/240 V AC	250V	800V	432 28	72 28	SPDT DPDT DPDT	HS HD † HR ‡
	DC13 R300	0.22/0.1A @ 125/250V DC						
5 Amps @ 250V AC and 2 Amps @ 30V DC	AC14 D300	0.6/0.3A @ 120/240 V AC	250V	500V	432 28	72 28	SPDT DPDT	HP HQ †
	DC13 R300	0.22/0.1A @ 125/250V DC						
1 Amp @ 125V AC and 1 Amp @ 30V DC Gold Alloy contacts—see note	AC14 E150	0.3A @ 120VAC	125V	500V	216	36	SPDT DPDT DPDT	HV HW † HY ‡

† 2 Single pole, double throw, simultaneous falling under pressure
‡ 2 Single pole, double throw, simultaneous falling under pressure

The switch contacts are hermetically sealed inside a stainless steel enclosure for protection against aggressive and corrosive atmospheres.

 CSA listing applies to the explosionproof hermetically sealed switch which is suitable for use in hazardous areas as defined by NEC Article 500, Class I Groups A, B, C, D Class II Groups E, F, G Division 1 and 2

NOTE: For low energy circuits e.g. 30V and up to 100mA, we recommend using gold alloy contact switches.
NOTE: For Enclosure codes 4 and 5, HS, HD and HR switching codes are unsuitable. Use gold contact switches.
 U_i = rated insulation voltage U_{imp} = rated impulse to withstand voltage across contacts.

Process Connection

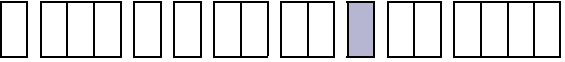
TABLE 7 

Other thread specifications and sizes are available without using adaptors.

Adaptors are available for applications where their use is permitted. Apply for details.

	Code
Rc 1/4 (1/4 BSP tr INT) to (ISO 7/1)	A
1/4—18 NPT INTERNAL	F
1/2—14 NPT INTERNAL	H
1/2—14 NPT EXTERNAL	J

Options & Treatments

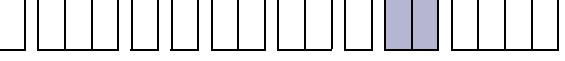
TABLE 8 

Combinations available, apply for details.

	Code
Tropicalisation High humidity atmospheres	01
Marine and Offshore Saline atmosphere or salt spray	02
Ammonia Process (wetted) parts and construction suitable for atmospheric ammonia	03
Oxygen Service Process (wetted) parts are cleaned for oxygen and are oil free	04
Pipe mounting Bracket Permits local 2" pipework to be utilized for mounting the instrument. Details on application.	10
Tag Stainless steel fixed to enclosure.	20
Tag Stainless steel tied to enclosure.	30
No options or Treatments Use this code when Special Engineering is required without options and treatments	00
Epoxy Paint for aluminium enclosures W, H and T in Table 1	50

GR Series
Models: GR3 & GR6

Special Engineering

Last 4 digits of model code only used when special engineering is required.

TABLE 9

	Code
Please consult Delta sales engineering for special requirements	TBA

Performance Data

TABLE 10

Bar Units

FIXED SWITCHING DIFFERENTIAL

Due to manufacturing tolerances, the figures quoted in these tables are for guidance only.

Should the differential be critical for specific applications our engineers should be consulted prior to ordering.

Code	Range mbar/bar	P _{max} Bar	Model	Microswitch - Option Switching Differential mbar					
				HS	HD/HR	HP	HQ/HT	HV	HW/HY
BC	12.5 to 12.5	1	GR3	1.5	3	2.5	3.5	1.5	3
BD	6 to 40	110	GR3	7.5	14	11	14	7.5	14
		250	GR6						
CB	25 to 160	110	GR3	16.5	20.5	19	23	16.5	20.5
		250	GR6						
CE	100 to 600	110	GR3	40	40	20	20	40	40
		250	GR6						
DC	0.4 to 2.5	110	GR3	150	200	180	280	150	200
		250	GR6						
DD	0.6 to 4	110	GR3	350	400	250	200	350	400
		250	GR6						
EA	1.6 to 10	110	GR3	800	1000	400	560	800	1000
		250	GR6						

PSI Units

Code	Range Ins H ₂ O/PSI	P _{max} Psi	Model	Microswitch - Option Switching Differential mbar					
				HS	HD/HR	HP	HQ/HT	HV	HW/HY
BU	-5.0 to +5.0	14.5	GR3	0.6	1.2	1	1.4	0.6	1.2
BY	2.5 to 16	1600	GR3	3	5.6	4.4	5.6	3	5.6
		3500	GR6						
CS	10 to 64	1600	GR3	6.6	8.2	7.6	9.2	6.6	8.2
		3500	GR6						
CK	1.5 to 8.5	1600	GR3	0.6	0.6	0.3	0.3	0.6	0.6
		3500	GR6						
DP	6 to 40	1600	GR3	2.2	3	2.6	4	2.2	3
		3500	GR6						
DT	10 to 60	1600	GR3	5	6	3.6	2.9	5	6
		3500	GR6						
EH	25 to 160	1600	GR3	11.6	14.5	5.8	8	11.6	14.5
		3500	GR6						

GR Series
Models: GR3 & GR6

Electrical Connections

Flying Lead

High duty PVC insulated 1.19mm²/18AWG factory sealed flying leads. Rated insulation voltage CSA 600V.

Terminal Enclosures

Suitable for conductor sizes up to 2.5mm²/14AWG non-pinching, clamped.

Earthing/Grounding

An earthing facility is provided. Flying lead versions have separate earth/ground conductor. Terminal enclosures have additional internal earthing/grounding facilities.

Dielectric Strength

The electrical assembly is capable of withstanding *1.5kV between live parts and earth/ground and 500V between open contacts.

Optional Extras

Chemical Seals

Chemical seals of our own or proprietary manufacture can be fitted when required.

Mounting Position/Location/Installation

Vertical as shown, IN DIMENSIONS, taking care to avoid siting in locations that transmit excessive shock or vibration. For further advice contact our engineers.

Electrical Isolation

These products are not suitable for electrical isolation. Always isolate circuit separately to carry out any electrical work.

Pollution degree (EN60947-5-1)

All switches rated IP66 are suitable for use in pollution degree 3. Ref. IEC 947-5-1.

Approvals

EUROPEAN DIRECTIVES



Low voltage Directive (LVD) 2014/35/EU.
Compliant to LVD



ATEX Directive 2014/34/EU

INTRINSIC SAFETY:
Certificate No. Baseefa06ATEX0091X
EN 60079-0, EN 60079-11, EN 60079-26, EN 61241-0. EN 61241-11

For Zone 0 models (**Enclosure code 4/5, see table 1**)

II 1 GD Ex ia IIC T6 Ga Ex ia IIIC T85°C Da IP6x (-40°C ≤ Tamb ≤ +60°C)

II 1 GD Ex ia IIC T4 Ga Ex ia IIIC T135°C Da IP6x (-40°C ≤ Tamb ≤ +85°C)

FLAMEPROOF:
Certificate No. Baseefa02ATEX0214X
EN 60079-0, EN 60079-1,

For Zone 1 models (**Enclosure code H/R, see table 1**)

II 2 G Ex d IIC T6 (Tamb -40°C to +65°C)

II 2 G Ex d IIC T4 (Tamb -40°C to +85°C)

INTEGRAL INCREASED SAFETY TERMINAL
Certificate No. BASEEFA03ATEX0089X
EN 60079-0:2006, EN 60079-7:2006

For Terminal Enclosures code J, see table 3

II 2 G Ex e II T6

GLOBAL CERTIFICATION



CANADIAN STANDARDS ASSOCIATION
Switches - Automatic - Pressure Type - for hazardous locations
Enclosure codes T & U.
Terminal enclosure code A.
Class 1, Groups A, B, C & D Class II, Groups E, F, G.
LR67110-5

Dimensions

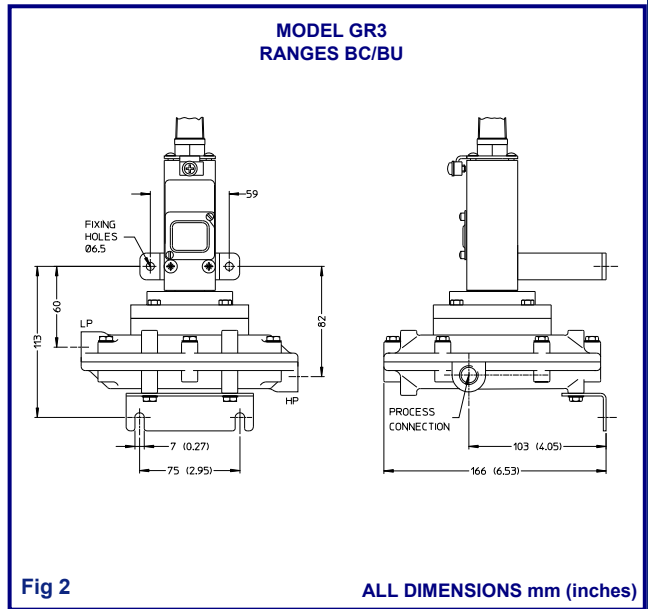
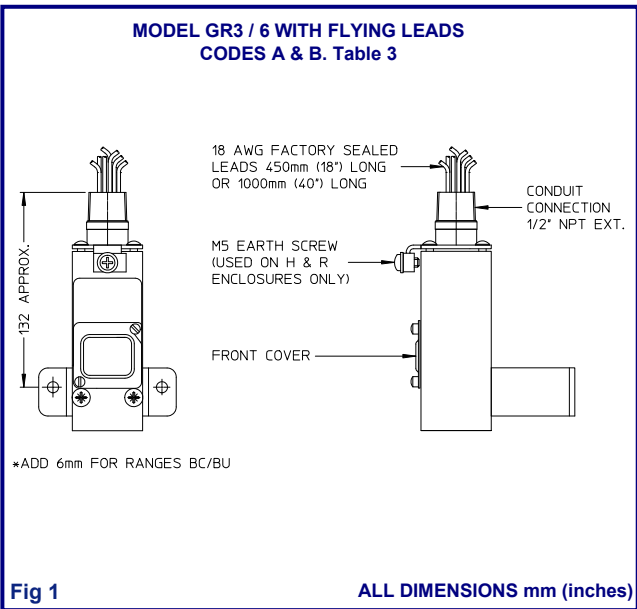

GR Series
Models: GR3 & GR6

Dimensions

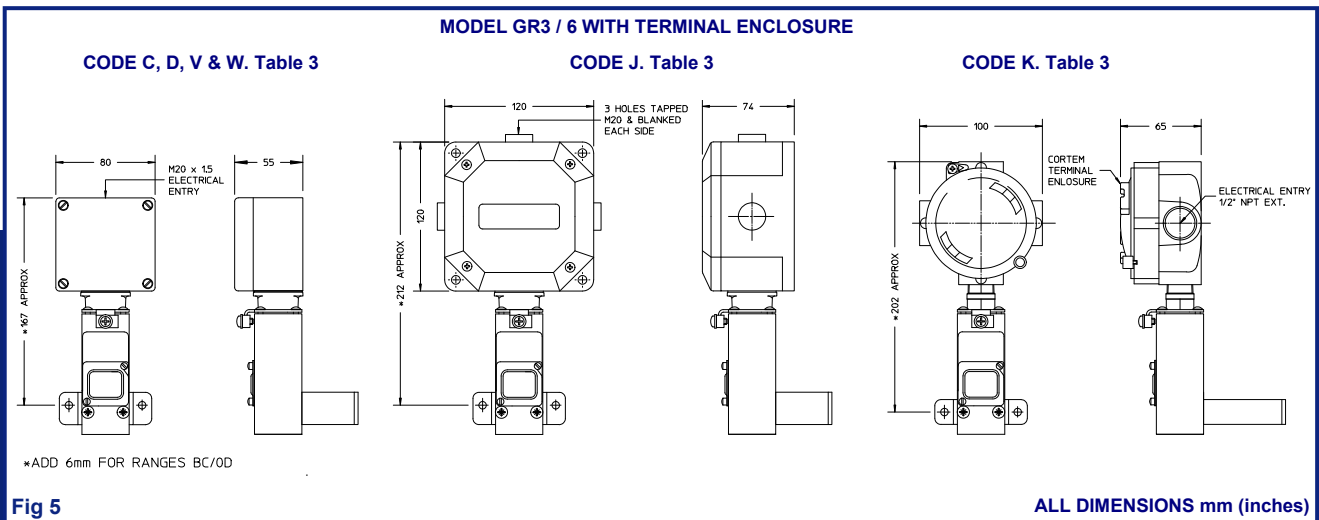
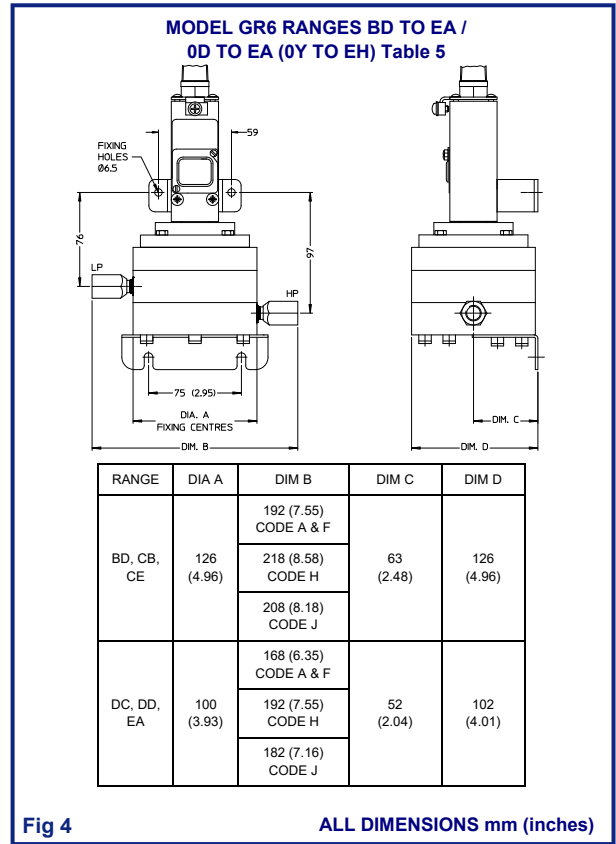
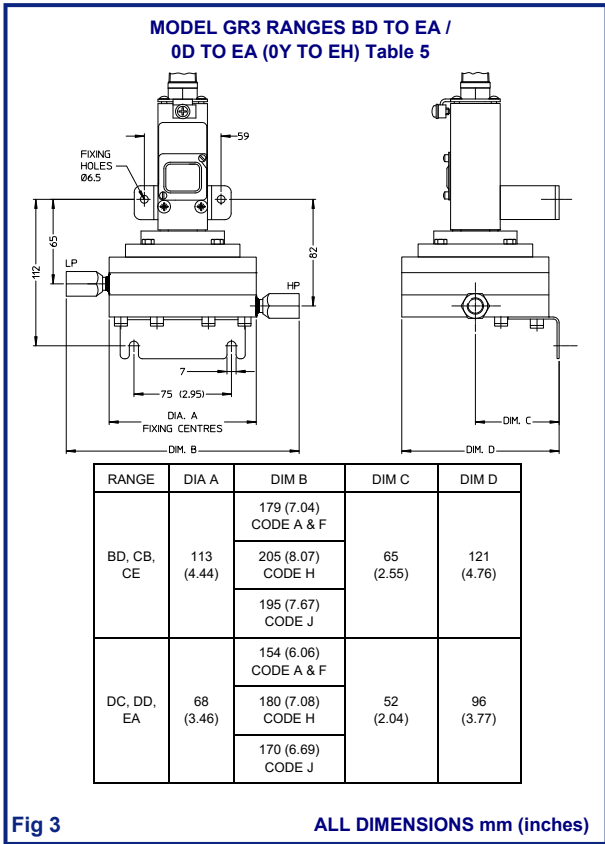

GR Series
Models: GR3 & GR6

In the interest of development and improvement Delta Mobrey Ltd, reserves the right to amend, without notice, details contained in this publication. No legal liability will be accepted by Delta Mobrey Ltd for any errors, omissions or amendments.

Delta Mobrey Limited
Riverside Business Park, Dogflud Way, Farnham, Surrey GU9 7SS, UK.
T+44 (0)1252 729140 F+44 (0)1252 729168 E sales@delta-mobrey.com W www.delta-mobrey.com

